



Delta

WATER SOFTENERS



Ontario 4

100% GREEN

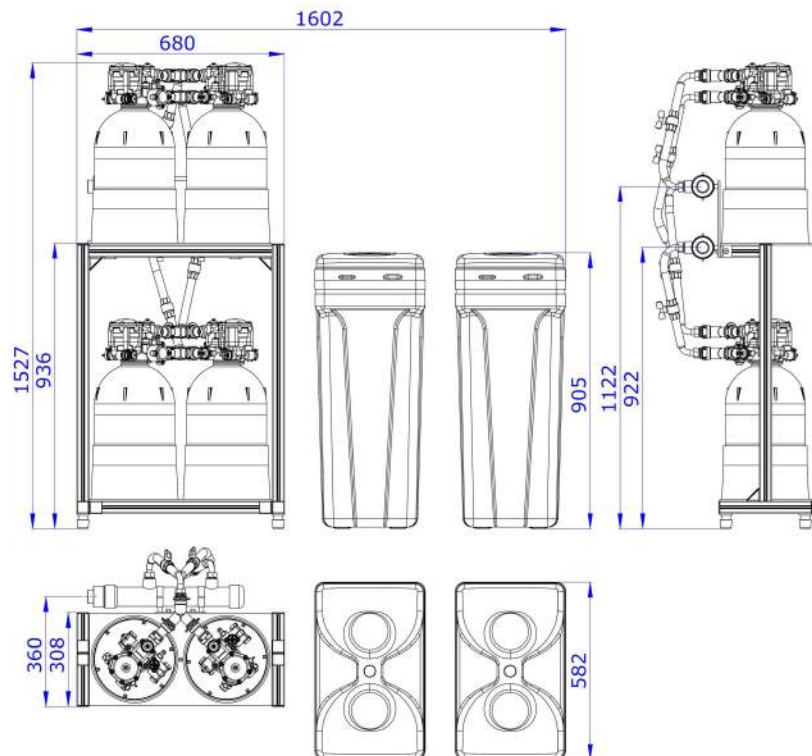

Technical Data

Resine Volume (liter)	48 (4 x 12)
Connection (inch)	1"1/4
Working pressure(bar)	1-8* **
Peak flow rate (p. drop=1bar) (m ³ /h)	8.4
Nominal flow rate (p. drop=1bar) (m ³ /h)	6.2
Exchange capacity (m ³ /ppm CaCO ₃)	2400
Water usage / regeneration (liter)	200 (50 x 4)
Salt usage / regeneration (Kg)	4.8 (1.2 x 4)
Max. temperature (°C)	50
Max. water consumption (24h, 300ppm) (m ³)	16

* Minimum outlet pressure after the softener has to be 0.8bar or higher

** The total pressure on the complete system should never be higher than 6 bar